

Fasi installazione di Hercules e Pegasus

Fasi installazione di Hercules e Pegasus

1. Realizzazione del Plinto

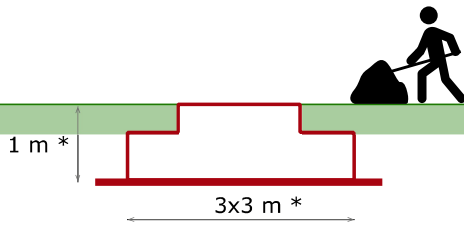

* in funzione delle condizioni del sito

2. Montaggio razze e vele sul cavalletto



tecnico tecnico operatore gru

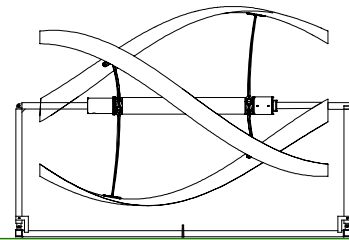

3. Installazione Torre



tecnico tecnico operatore piattaforma operatore gru

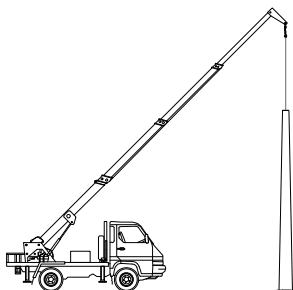
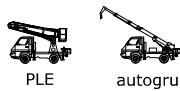

4. Posizionamento rotore sulla torre



tecnico tecnico operatore piattaforma operatore gru

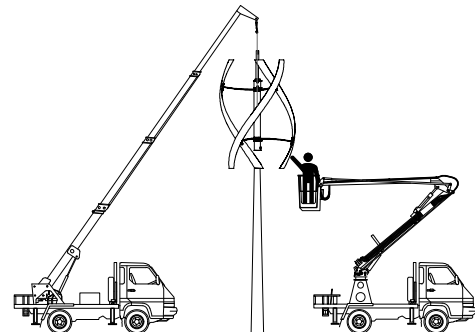
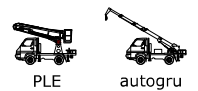

5. Collegamenti elettrici



tecnico

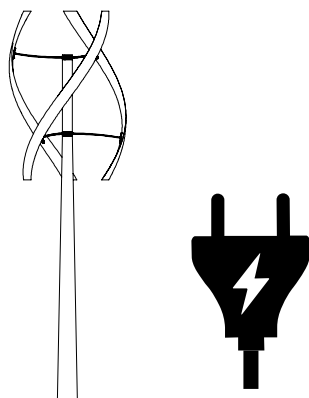

6. Collaudo e messa in funzione

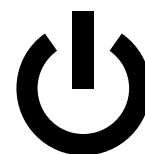

Autogru

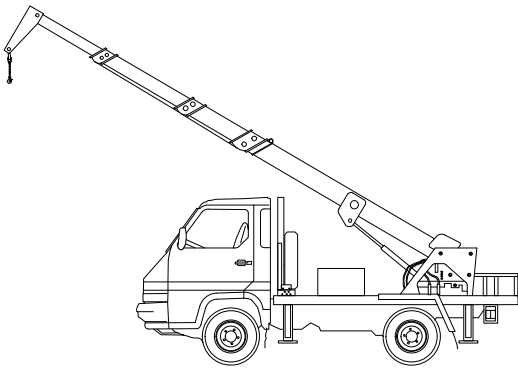

- Portata 6÷11T con almeno 15m di sbraccio
- Sollevamento del carico a 15 m di altezza, a parità tra livello di attacco base torre e livello di stabilizzazione della gru

Piattaforma di lavoro mobile elevabile (PLE)

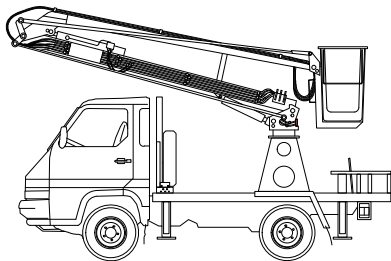

- Dimensione cesto minime 1,40x0,70 m
- Altezza di lavoro 16÷23 m